

Stabbi-HIFI

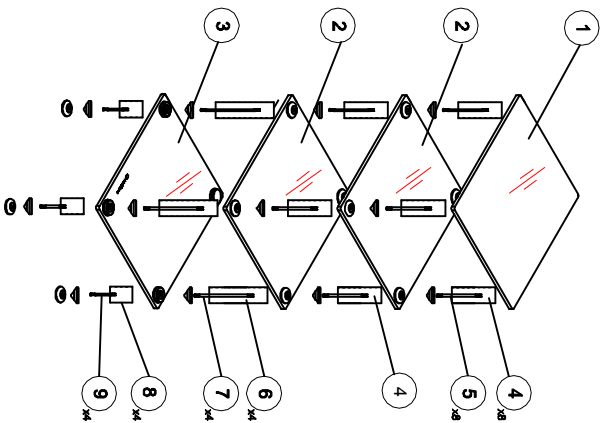
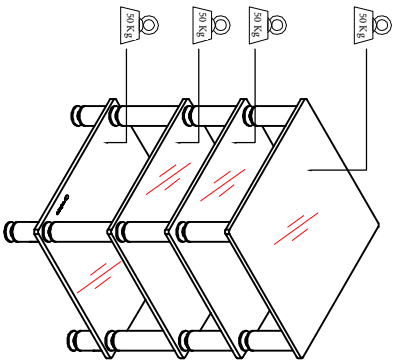

Lire attentivement la notice avant de commencer l'assemblage.
 Contrôler et trier les différents éléments suivant les illustrations.
 Assembler le meuble en respectant les phases de montage.
 Nettoyer à l'aide d'un chiffon humide. Ne pas utiliser de solvant

Carefully read these instructions before starting. Use the illustrations to identify the content of the package, then follow the numbered sequence of assembly.
 Use a damp cloth for routine cleaning. Do not use solvent cleaners.

Assembler le meuble sur une surface plane et propre pour éviter les rayures et dommages sur les parties finies.
 Ne serrer totalement les vis qu'à la fin du montage.
 Ne pas déplacer le meuble avec le TV dessus.

Assemble the stand on a flat and clean surface to avoid scratch and damage on the finish parts.
 Secure the screws tightly at the end of assembly.
 Don't move the stand with the TV !

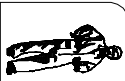

X2
X16

A



B



X4

C

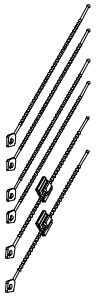

=30MIN

1

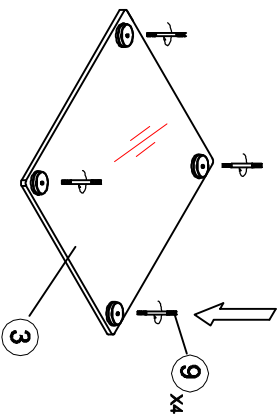

2

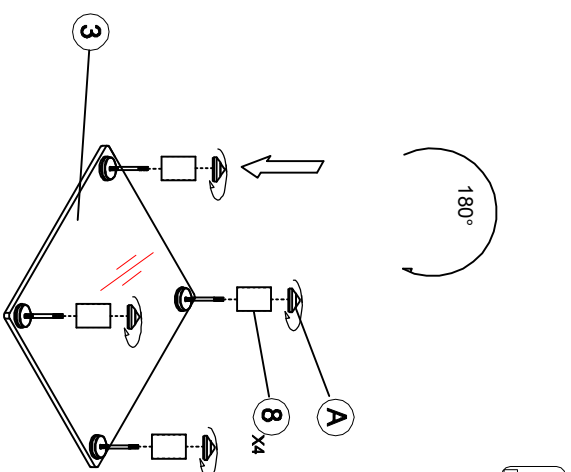

180°

3

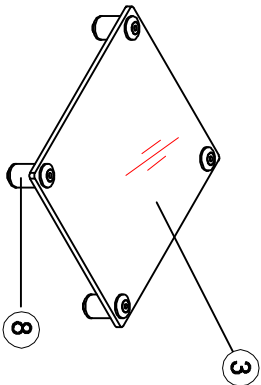

4

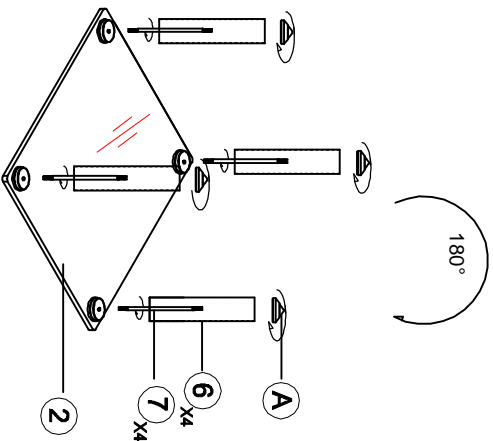

5

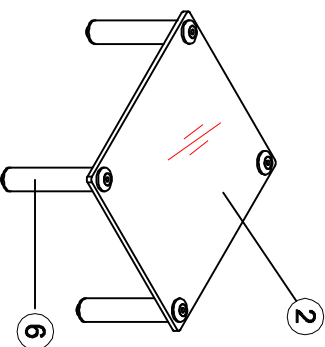

6

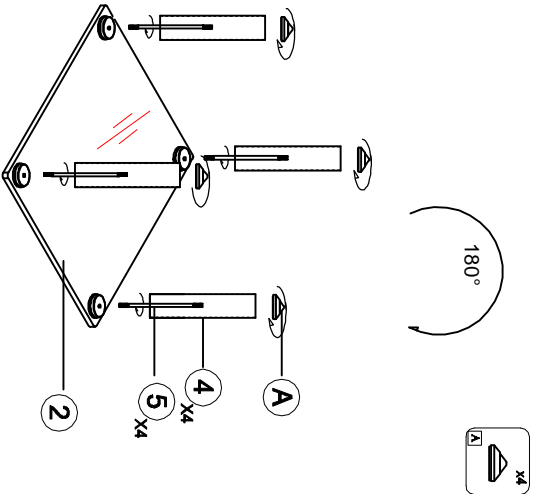

7

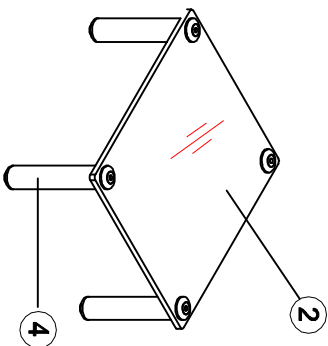

8

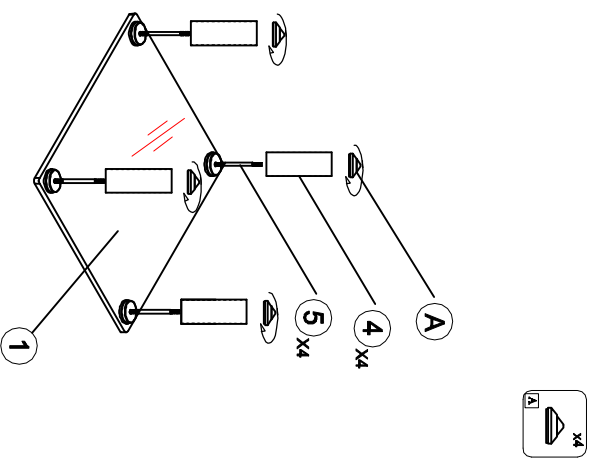

9

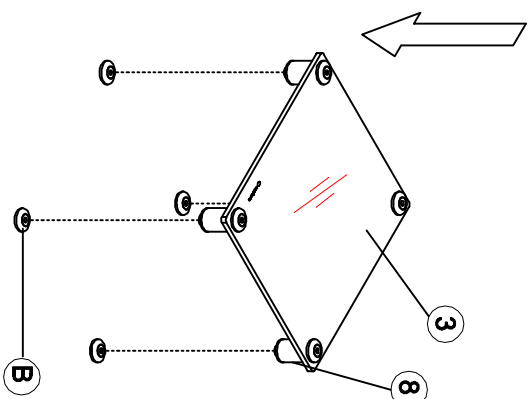

10

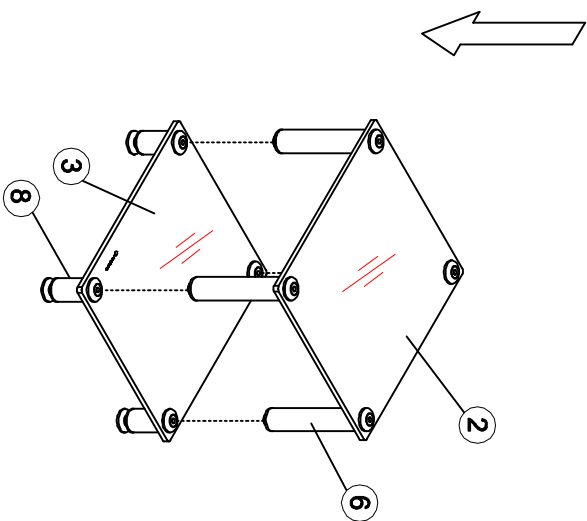

11

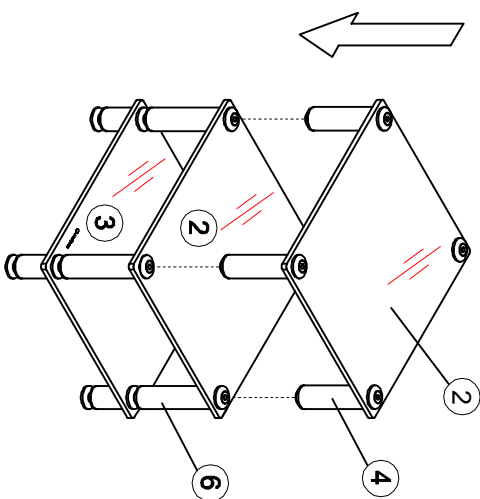

12

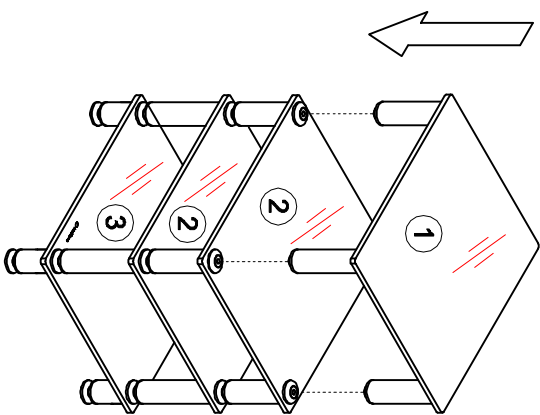

13

